

NORMANDE

EN Hob / User Manual

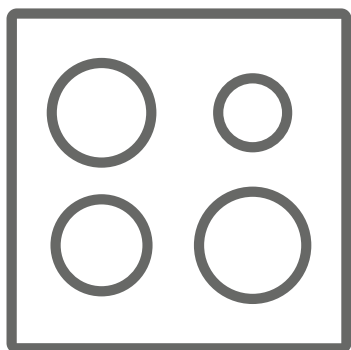





ND6001B
ND6026W

Thank you for choosing this product.

This User Manual contains important safety information and instructions on the operation and maintenance of your appliance.

Please take the time to read this User Manual before using your appliance and keep this book for future reference.

Icon	Type	Meaning
	WARNING	Serious injury or death risk
	RISK OF ELECTRIC SHOCK	Dangerous voltage risk
	FIRE	Warning; Risk of fire / flammable materials
	CAUTION	Injury or property damage risk
	IMPORTANT / NOTE	Operating the system correctly

CONTENTS

1.SAFETY INSTRUCTIONS.....	4
1.1 General Safety Warnings	4
1.2 Installation Warnings	7
1.3 During Use	7
1.4 During Cleaning and Maintenance	8
2.INSTALLATION AND PREPARATION FOR USE.....	10
2.1 Instructions for the Installer	10
2.2 Gas Connection.....	12
2.3 Changing the gas inlet.....	14
2.4 Electrical Connection and Safety (if available).....	14
3.PRODUCT FEATURES.....	16
4.USE OF PRODUCT	17
4.1 Use of gas burners	17
5.CLEANING AND MAINTENANCE.....	18
5.1 Cleaning	18
5.2 Maintenance.....	19
6.TROUBLESHOOTING&TRANSPORT	20
6.1 Troubleshooting.....	20
6.2 Transport	20
7.TECHNICAL SPECIFICATIONS.....	21
7.1 Injector Table	21



1. SAFETY INSTRUCTIONS

- Carefully read all instructions before using your appliance and keep them in a convenient place for reference when necessary.
- This manual has been prepared for more than one model therefore your appliance may not have some of the features described within. For this reason, it is important to pay particular attention to any figures whilst reading the operating manual.

1.1 GENERAL SAFETY WARNINGS

- This appliance can be used by children aged from 8 years and above and by persons with reduced physical, sensory or mental capabilities or lack of experience and knowledge if they have been given supervision or instruction concerning use of the appliance in a safe way and understand the hazards involved. Children should not play with the appliance. Cleaning and user maintenance should not be made by children without supervision.

 **WARNING:** The appliance and its accessible parts become hot during use. Care should be taken to avoid touching heating elements. Keep children less than 8 years of age away unless they are continually supervised.

  **WARNING:** Unattended cooking on a hob with fat or oil can be dangerous and may result in fire. NEVER try to extinguish such a fire with water, but switch off the appliance and cover the flame with a lid or a fire blanket.

 **CAUTION:** The cooking process has to be supervised. A short term cooking process has to be supervised continuously

 **WARNING:** Danger of fire: Do not store items on the cooking surfaces.

 **WARNING:** If the surface is cracked, switch off the appliance to avoid the possibility of electric shock.

- For models which incorporate a hob lid, clean any spillages off the lid before use and allow the cooker to cool before closing the lid.
- Do not operate the appliance by means of an external timer or separate remote-control system.
- Do not use harsh abrasive cleaners or scourers to clean oven surfaces. They can scratch the surfaces which may result in shattering of the door glass or damage to surfaces.
- Do not use steam cleaners to clean the appliance.
- Your appliance is produced in accordance with all applicable local and international standards and regulations.
- Maintenance and repair work should only be carried out by authorised service technicians. Installation and repair work that is carried out by unauthorised technicians may be dangerous. Do not alter or modify the specifications of the appliance in any way. Inappropriate hob guards can cause accidents.
- Before connecting your appliance, make sure that the local distribution conditions (nature of the gas and gas pressure or electricity voltage and frequency) and the specifications of the appliance are compatible. The specifications for this appliance are stated on the label.

 **CAUTION:** This appliance is designed only for cooking food and is intended for indoor domestic household use only. It should not be used for any other purpose or in any other application, such as for

non-domestic use, in a commercial environment or for heating a room.

- This appliance is not connected to a ventilation device. It shall be installed and connected in accordance with current installation regulations. Particular attention should be given to the relevant requirements regarding ventilation.
- If the burner has not lit after 15 seconds, stop operating the device and open the compartment door. Wait at least 1 minute before attempting to ignite the burner again.
- These instructions are only valid if the correct country symbol appears on the appliance. If the symbol does not appear on the appliance, refer to the technical instructions which describe how to modify the appliance to match the conditions of use of the country.
- All possible measures have been taken to ensure your safety. Since the glass may break, care should be taken when cleaning. Avoid hitting or knocking the glass with accessories.
- Make sure that the supply cord is not trapped or damaged during installation. If the supply cord is damaged, it must be replaced by the manufacturer, its service agent or similarly qualified persons in order to prevent a hazard.
- If your appliance is provided with a cooking hotplate made of glass or glass ceramic:
 - ⚠ **CAUTION:** “In case of hotplate glass breakage”:
 - immediately shut off all burners and any electrical heating elements and isolate the appliance from the power supply,
 - do not touch the appliance surface,
 - do not use the appliance.

- Please keep children and animals away from this appliance.

1.2 INSTALLATION WARNINGS

- Do not operate the appliance before it is fully installed.
- The appliance must be installed by an authorised technician. The manufacturer is not responsible for any damage that might be caused by defective placement and installation by unauthorised people.
- When the appliance is unpacked, make sure that it has not been damaged during transportation. In the case of a defect do not use the appliance and contact a qualified service agent immediately. The materials used for packaging (nylon, staplers, styrofoam, etc.) may be harmful to children and they should be collected and removed immediately.
- Protect your appliance from the atmosphere. Do not expose it to sun, rain, snow, dust or excessive humidity.
- Materials around the appliance (i.e. cabinets) must be able to withstand a minimum temperature of 100°C.
- The temperature of the bottom surface of the hob may rise during operation, therefore a board must be installed underneath the product.

1.3 DURING USE

- Do not put flammable or combustible materials in or near the appliance while it is operating.



Do not leave the cooker unattended when cooking with solid or liquid oils. They may catch fire under extreme heating conditions. Never pour water on to flames that are caused by oil, instead switch the

cooker off and cover the pan with its lid or a fire blanket.

- Always position pans over the centre of the cooking zone, and turn the handles to a safe position so they cannot be knocked or grabbed.
- If the product will not be used for a long period of time, turn the main control switch off. Turn the gas valve off when a gas appliance is not in use.
- Make sure the appliance control knobs are always in the “0” (stop) position when the appliance is not in use.

 **CAUTION:** The use of a gas cooking appliance results in the production of heat, moisture and products of combustion in the room in which it is installed. Ensure that the kitchen is well ventilated especially when the appliance is in use. Keep natural ventilation holes open or install a mechanical ventilation device (mechanical extractor hood).

- Prolonged intensive use of the appliance may call for additional ventilation, such as opening a window, or for more effective ventilation, for example, increasing the level of mechanical ventilation where necessary.

1.4 DURING CLEANING AND MAINTENANCE

- Make sure that your appliance is switched off at the mains before carrying out any cleaning or maintenance operations.
- Do not remove the control knobs to clean the control panel.
- To maintain the efficiency and safety of your appliance, we recommend you always use original spare parts and to call our authorised service agents when needed.

CE Declaration of conformity

CE We declare that our products meet the applicable European Directives, Decisions and Regulations and the requirements listed in the standards referenced.

This appliance has been designed to be used only for home cooking. Any other use (such as heating a room) is improper and dangerous.

 The operating instructions apply to several models. You may notice differences between these instructions and your model.

Disposal of your old machine



This symbol on the product or on its packaging indicates that this product should not be treated as household waste. Instead it should be handed over to the applicable collection point for the recycling of electrical and electronic equipment. By ensuring this product is disposed of correctly, you will help prevent potential negative consequences for the environment and human health, which could otherwise be caused by inappropriate waste handling of this product. For more detailed information about recycling of this product, please contact your local city office, your household waste disposal service or the retailer who you purchased this product from.

2. INSTALLATION AND PREPARATION FOR USE

! WARNING : This appliance must be installed by an authorised service person or qualified technician, according to the instructions in this guide and in compliance with the current local regulations.

- Incorrect installation may cause harm and damage, for which the manufacturer accepts no responsibility and the warranty will not be valid.
- Prior to installation, ensure that the local distribution conditions (electricity voltage and frequency and/or nature of the gas and gas pressure) and the adjustments of the appliance are compatible. The adjustment conditions for this appliance are stated on the label.
- The laws, ordinances, directives and standards in force in the country of use are to be followed (safety regulations, proper recycling in accordance with the regulations, etc.).

2.1 INSTRUCTIONS FOR THE INSTALLER

Ventilation requirements

- For rooms with a volume of less than 5 m³, permanent ventilation of 100 cm² free area is required.
- For rooms with a volume of between 5 m³ and 10 m³, permanent ventilation of 50 cm² free area will be required, unless the room has a door which opens directly to outside air in which case no permanent ventilation is required.
- For rooms with a volume greater than 10 m³, no permanent ventilation is required.

! Important: Regardless of room size, all rooms containing the appliance must have direct access to outside air via an openable window or equivalent.

Emptying of burned gases from the environment

Gas appliances expel burned gas waste to the outside air, either directly or via a cooker hood with a chimney. If it is not possible to install a cooker hood, install a fan on the window or wall that has access to fresh air. The fan must have the capacity to change the volume of air in the kitchen a minimum of 4-5 times per hour.

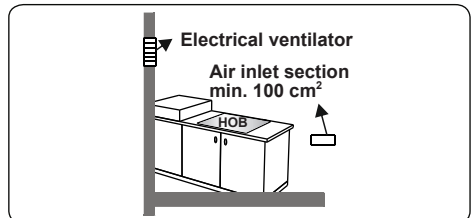
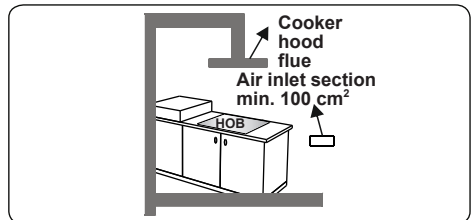
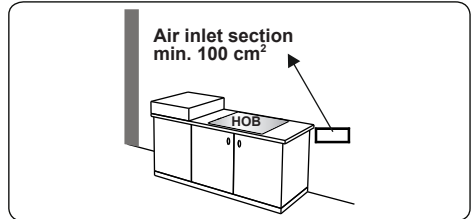
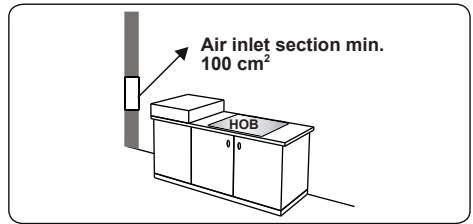

General instructions

- After removing the packaging material from the appliance and its accessories, ensure that the appliance is not damaged. If you suspect any damage, do not use it and contact an authorised service person or qualified technician immediately.
- Make sure that there are no flammable or combustible materials in the close vicinity, such as curtains, oil, cloth etc. which may catch fire.
- The worktop and furniture surrounding the appliance must be made of materials resistant to temperatures above 100°C.

- If a cooker hood or cupboard is to be installed above the appliance, the safety distance between cooktop and any cupboard/cooker hood should be as shown below.

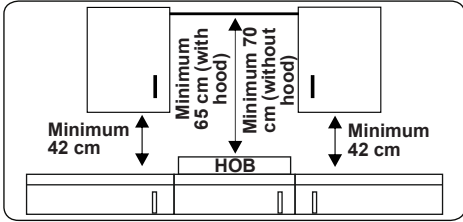

- The appliance should not be installed directly above a dishwasher, fridge, freezer, washing machine or clothes dryer.
- If the base of the appliance is accessible by hand, a barrier made from a suitable material must be fitted below the base of the appliance, ensuring that there is no access to the base of the appliance.
- The appliance can be placed close to

other furniture on condition that in the area where the appliance is set up, the furniture's height does not exceed the height of the cooktop.

Installation of the Hob

The appliance is supplied with an installation kit including adhesive sealing material, fixing brackets and screws.

- Cut the aperture dimensions as indicated in the figure. Locate the aperture on the worktop so that, after the hob is installed, the following requirements are followed.

B (mm)	594	min. A (mm)	50
T (mm)	523	min. C (mm)	100
H (mm)	44	min. E (mm)	500
C1 (mm)	560	min. F (mm)	10
C2 (mm)	490	G (mm)	20
D (mm)	50	I (mm)	25
J (mm)	5		

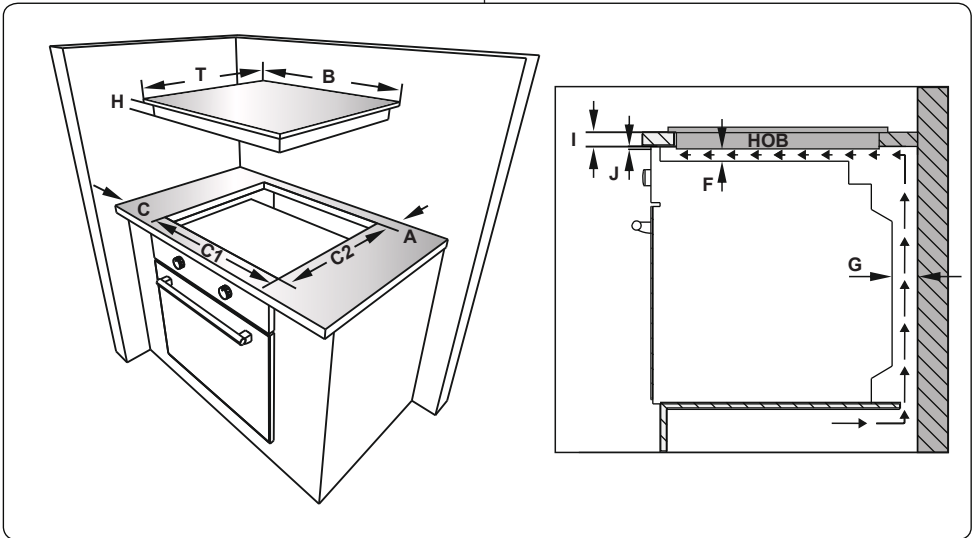

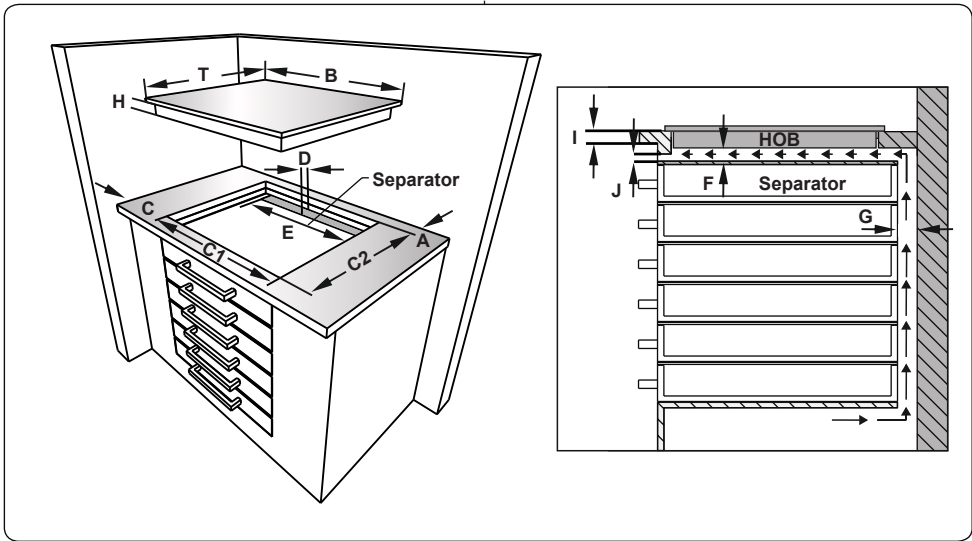

- Apply the supplied one-sided self-adhesive sealing tape all the way around the lower edge of the cooktop. Do not stretch it.

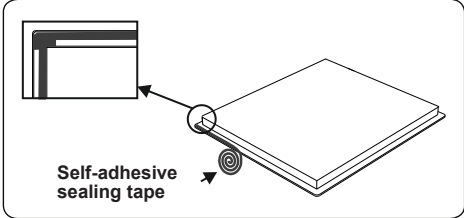

- Insert the appliance into the aperture and fix in position using the brackets (A) and screws (B). Adjust the position of the brackets depending on the thickness of the worktop and tighten the screws evenly.

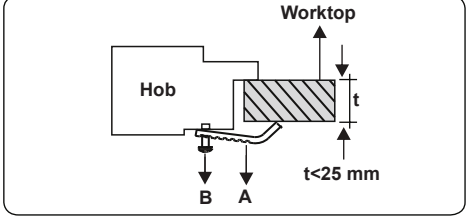
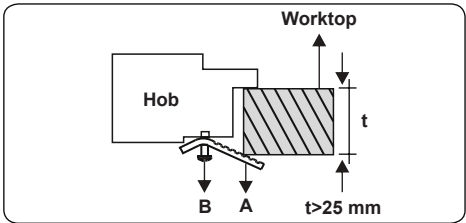

Important: If the appliance is to be installed above a cupboard or drawer it is absolutely essential that you place a separator between the base of the appliance and the drawer unit.

2.2 GAS CONNECTION

Assembly of gas supply and leakage check

Connect the appliance in accordance with applicable local and international standards and regulations. First, check what type of gas is installed on the cooker. This information is available on a sticker on the back of the cooker. You can find

the information related to appropriate gas types and appropriate gas injectors in the technical data table. Check that the feeding gas pressure matches the values on the technical data table, to be able to get the most efficient use and to ensure the minimum gas consumption. If the pressure of used gas is different than the values stated or is not stable in your area, it may be necessary to assemble an available pressure regulator on the gas inlet. You should contact an authorised service centre to make these adjustments.

Points that must be checked during flexible hose assembly:

- If the gas connection is made by a flexible hose fixed onto the gas inlet of the hob, it must be fixed on by a pipe collar.
- Connect your appliance with a short and durable hose that is as close as possible to the gas source.
- The permitted maximum length of the hose is 1.5 m.
- The device should be connected in line with the relevant local gas standards.
- The hose must be kept clear of areas that may heat up to temperatures of more than 90°C.
- The hose must not be cracked, torn, bent or folded.
- Keep the hose clear of sharp corners and objects that could move.
- Before you assemble the connection, you must make sure the hose is not damaged. Use bubbly water or leakage fluids to perform the check. Do not use a naked flame to check for gas leakage.
- All metal items that are used during gas connection must be free from rust. Check the expiry date of any components used for connection.

Points that must be checked during fixed gas connection assembly:

The method used to assemble a fixed gas connection (gas connection made by threads, e.g. a nut) varies according to the country you are in. The most common parts for your country will be supplied with your appliance. Any other parts required can be supplied as spare parts.

During connection, always keep the nut on the gas manifold fixed while rotating

the counter-part. Use appropriately-sized spanners for a safe connection. For surfaces between different components always use the seals provided in the gas conversion kit.

The seals used during connection should also be approved to be used in gas connections. Do not use plumbing seals for gas connections.

Remember that this appliance is ready to be connected to the gas supply in the country for which it has been produced. The main country of destination is marked on the rear cover of the appliance. If you need to use it in another country, any of the connections in the figure below may be required. In such a case, contact local authorities to learn the correct gas connection.

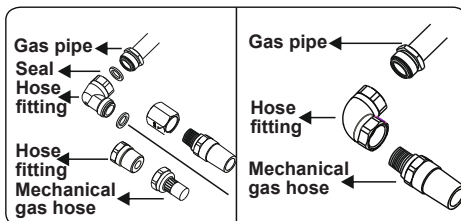
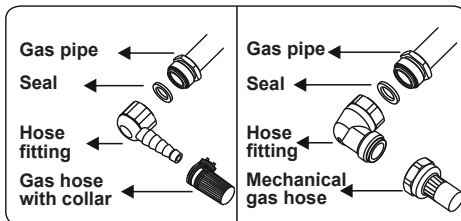
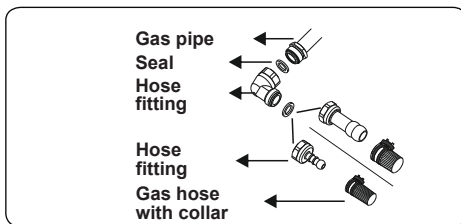

The Cooker must be installed and maintained by a suitably qualified gas registered technician in accordance with current safety legislation.

⚠ WARNING: Do not use a naked flame to check for gas leaks.

Gas Conversion (If available)

Your appliance is designed to be operated

with LPG/NG gas. The gas burners can be adapted to different types of gas, by replacing the corresponding injectors and adjusting the minimum flame length suitable to the gas in use. For this purpose, the following steps should be performed.

Changing injectors

Hob burners

- Cut off the main gas supply and unplug the appliance from the mains electrical supply.
- Remove the burner caps and the adapters.
- Use a 7 mm spanner to unscrew the injectors.
- Replace the injector with the ones from the gas conversion kit, with the correct diameters for the type of gas that is going to be used, according to the gas injector table.

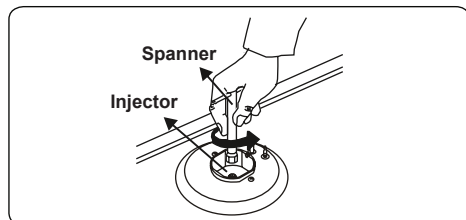
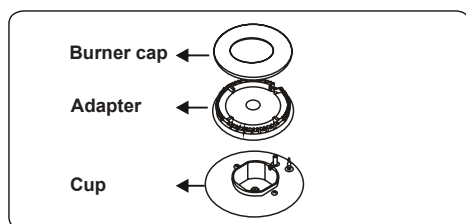

Adjusting the reduced flame position

First of all, make sure that the appliance is unplugged from the mains electrical supply and that the gas feed is open. The minimum flame position is adjusted with a flat screw located on the valve. For valves with a flame failure safety device, the screw is located on the side of the valve spindle as shown in the figures. For valves without a flame failure safety device, the screw is located inside the valve spindle as shown in the figure. To make adjusting the flame position easier, we recommend that you remove the control panel (and the micro switch if your model has one) during the alteration.

To determine the minimum position, ignite the burners and leave them on in the minimum position. With the help of a small screwdriver, fasten or loosen the bypass screw by around 90 degrees. When the flame has a length of at least 4mm, the gas is well distributed. Make sure that the flame does not die out when passing from the maximum position to the minimum position. Create an artificial wind with your hand towards the flame to see if the flames are stable.

The bypass screw must be loosened for conversion from LPG to NG. For conversion from NG to LPG, the bypass screw must be tightened. Make sure that the appliance is unplugged from the mains electrical supply and that the gas feed is open.

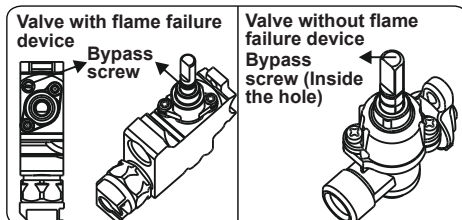
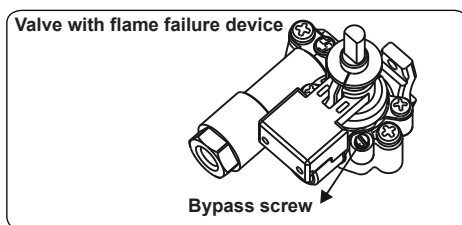

2.3 CHANGING THE GAS INLET

For some countries, the gas inlet type can be different for NG/LPG gases. In this case, remove the current connection components and nuts (if any) and connect the new gas supply accordingly. In all conditions, all components used in gas connections should be approved by local and/or international authorities. In all gas connections, refer to the "Assembly of gas supply and leakage check" clause explained above.

2.4 ELECTRICAL CONNECTION AND SAFETY (IF AVAILABLE)

⚠ WARNING: The electrical connection of this appliance should be carried out by an authorised service person or qualified electrician, according to the instructions in this guide and in compliance

with the current local regulations.

! WARNING: THE APPLIANCE MUST BE EARTHED.

- Before connecting the appliance to the power supply, the voltage rating of the appliance (stamped on the appliance identification plate) must be checked for correspondence to the available mains supply voltage, and the mains electric wiring should be capable of handling the appliance's power rating (also indicated on the identification plate).
- During installation, please ensure that isolated cables are used. An incorrect connection could damage your appliance. If the mains cable is damaged and needs to be replaced this should be done by a qualified personnel.
- Do not use adaptors, multiple sockets and/or extension leads.
- The supply cord should be kept away from hot parts of the appliance and must not be bent or compressed. Otherwise the cord may be damaged, causing a short circuit.
- If the appliance is not connected to the mains with a plug, a all-pole disconnecter switch (with at least 3 mm contact spacing) must be used in order to meet the safety regulations.
- The fused switch must be easily accessible once the appliance has been installed.
- Ensure all connections are adequately tightened.
- Fix the supply cable in the cable clamp and then close the cover.
- The terminal box connection is placed on the terminal box.

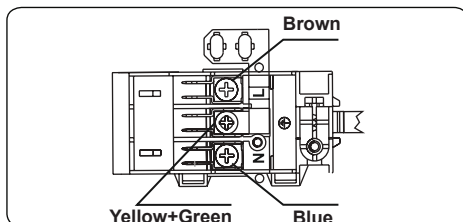

3. PRODUCT FEATURES



Important: Specifications for the product vary and the appearance of your appliance may differ from that shown in the figures below.

List of Components

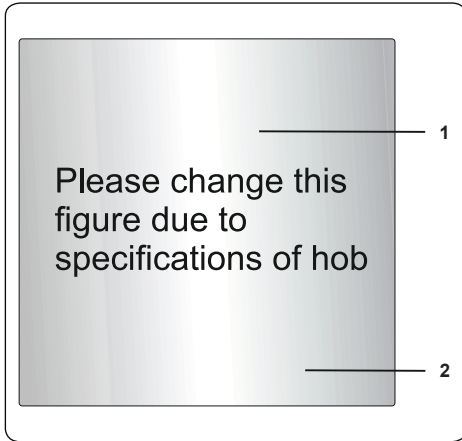

1. Gas Burner
2. Control Panel

4. USE OF PRODUCT

4.1 USE OF GAS BURNERS

Ignition of the burners

The position symbol above each control knob indicates the burner that the knob controls.

Manual Ignition of the Gas Burners

If your appliance is not equipped with an ignition aid, or in case there is a failure in the electric network, follow the procedures listed below.

For Hob Burners: Push in the knob of the burner you wish to ignite and keep it pressed while turning it anti-clockwise until the knob is in the 'maximum' position. Continue pressing the knob and hold a lit match, taper or other manual aid to the upper circumference of the burner. Move the ignition source away from the burner as soon as you see a stable flame.

Electrical ignition by control knob

Push in the knob of the burner you wish to ignite and keep it pressed while turning it anti-clockwise until the knob is in the 90 degrees position. The microswitch under the knob will create sparks through the spark plug for as long as the control knob is pressed. Press the knob until you see a stable flame on the burner.

Flame safety device

Hob burners

Hobs equipped with a flame failure device provide security in case of an accidentally extinguished flame. If such a case occurs, the device will block the burners gas lines and will avoid any accumulation of unburned gas. Wait 90 seconds before re-igniting an extinguished gas burner. Hob Controls

Hob burner

The knob has 3 positions: off (0), maximum (big flame symbol) and minimum (small flame symbol). Ignite the burner with the knob in the 'maximum' position; you can then adjust the flame length between the 'maximum' and 'minimum' positions. Do not operate the burners when the knob is between the 'maximum' and 'off' positions.

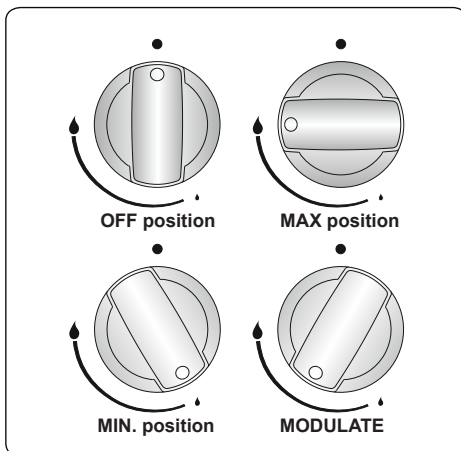

After ignition, visually check the flames. If you see a yellow tip, lifted or unstable flame, switch the gas flow off, then check the assembly of burner caps and crowns once they have cooled. Make sure there is no liquid in the burner caps. If the burner flames go out accidentally, switch the burners off, ventilate the kitchen with fresh air and wait at least 90 seconds before attempting re-ignition.

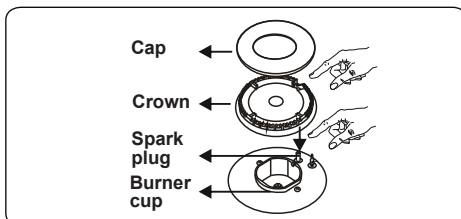

To switch the hob burners off, turn the hob burner knob clockwise to the '0' position or so that the marker on the hob burner knob points upwards.

Your hob has burners of different diameters. You will find that the most economical way of using gas is to choose the correct size gas burner for your cooking pan size and to bring the flame to the 'minimum' position once boiling point is reached. We recommend that you always cover your cooking pan to avoid heat loss.

To obtain maximum performance from the main burners, we suggest you use pots with the following flat bottom diameters. Using pots smaller than the minimum dimensions shown below will cause energy loss.

Rapid / Wok Burner	22-26 cm
Semi-rapid Burner	14-22 cm
Auxiliary Burner	12-18 cm

Make sure that the tips of the flames do not spread out from the outer circumference of the pan, as this may harm plastic accessories, such as handles.

Switch the main gas control valve off when the burners are not in use for prolonged periods of time.

WARNING:

- Only use flat-bottomed pans with thick bases.
- Make sure the bottom of the pan is dry before placing it on the burner.
- The temperature of accessible parts may become high while the appliance is operating. It is imperative that children and animals are kept well away from the burners during and after cooking.
- After use, the hob remains very hot for a prolonged period of time. Do not touch it and do not place any object on top of it.
- Never place knives, forks, spoons and lids on the hob as they will get hot and could cause serious burns.
- Do not allow pan handles or any other cooking utensils to project over the edge of the cooker top.

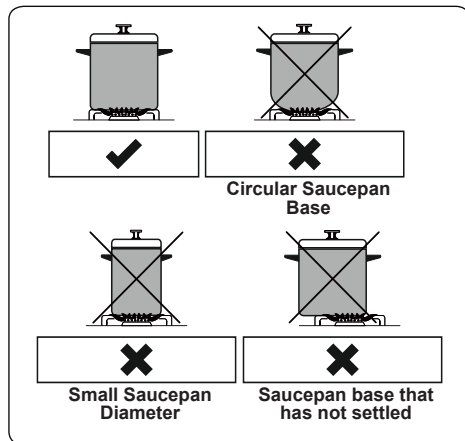



5. CLEANING AND MAINTENANCE



5.1 CLEANING

 **WARNING:** Switch off the appliance and allow it to cool before cleaning is to be carried out.

General Instructions

- Check whether the cleaning materials are appropriate and recommended by the manufacturer before use on your appliance.
- Use cream cleaners or liquid cleaners which do not contain particles. Do not use caustic (corrosive) creams, abrasive cleaning powders, rough wire wool or hard tools as they may damage the cooker surfaces.
-  Do not use cleaners that contain particles, as they may scratch the glass, enamelled and/or painted parts of your appliance.
- Should any liquids overflow, clean them immediately to avoid parts becoming damaged.
-  Do not use steam cleaners for cleaning any part of the appliance.

Cleaning the Gas Hob

- Clean the gas hob on a regular basis.
- Take off the pan supports, caps and crowns of the hob burners.
- Wipe the hob surface with a soft cloth soaked in soapy water. Then, wipe the hob surface over again with a wet cloth and dry it.
- Wash and rinse the hob-burner caps. Do not leave them wet. Dry them immediately with a dry cloth.
- Make sure you re-assemble all parts correctly after cleaning.
- The surfaces of the pan supports may become scratched over time due to use. This is not a production fault.
-  Do not use a metal sponge for cleaning any part of the hob.
-  Make sure no water gets into the burners as this may block the injectors.

Cleaning the Glass Parts (if available)

- Clean the glass parts of your appliance on a regular basis.
- Use a glass cleaner to clean the inside and outside of the glass parts. Then, rinse and dry them thoroughly with a dry cloth.

Cleaning the Enamelled Parts

- Clean the enamelled parts of your appliance on a regular basis.
- Wipe the enamelled parts with a soft cloth soaked in soapy water. Then, wipe them over again with a wet cloth and dry them.



Do not clean the enamelled parts while they are still hot from cooking.



Do not leave vinegar, coffee, milk, salt, water, lemon or tomato juice on the enamel for a long time.

Cleaning the Stainless Steel Parts (if available)

- Clean the stainless steel parts of your appliance on a regular basis.
- Wipe the stainless steel parts with a soft cloth soaked in only water. Then, dry them thoroughly with a dry cloth.



Do not clean the stainless steel parts while they are still hot from cooking.



Do not leave vinegar, coffee, milk, salt, water, lemon or tomato juice on the stainless steel for a long time.

5.2 MAINTENANCE

 **WARNING:** The maintenance of this appliance should be carried out by an authorised service person or qualified technician only.

Other Controls

- Periodically check expiration date of the gas connection pipe.
- Periodically check the gas connection pipe. If a defect is found, contact an authorised service provider to have it changed.
- If a defect is found while operating the control knobs of the appliance, contact an authorised service provider.

6. TROUBLESHOOTING&TRANSPORT

6.1 TROUBLESHOOTING



If you still have a problem with your appliance after checking these basic troubleshooting steps, please contact an authorised service person or qualified technician.

Problem	Possible Cause	Solution
Hob burners do not work.	The burners may be in the 'off' position. Supply gas pressure may not be correct. Power (if the appliance has an electric connection) is switched off.	Check the position of oven and/or grill burner's control knob. Check the gas supply and gas pressure. Check whether there is power supplied. Also check that other kitchen appliances are working.
Hob burners do not light.	Burner cap and crown are not assembled correctly. Supply gas pressure may not be correct. LPG cylinder (if applicable) may be depleted. Power (if the appliance has an electric connection) is switched off.	Ensure the burner parts have been placed correctly. Check the gas supply and gas pressure. LPG cylinder may need replacing. Check whether there is power supplied. Also check that other kitchen appliances are working.
Flame colour is orange/yellow.	Burner cap and crown are not assembled correctly. Different gas compositions.	Ensure the burner parts have been placed correctly. Due to the design of the burner, the flame can appear to be orange/yellow in certain areas of the burner. If you operate the appliance with natural gas, city natural gas may have different compositions. Do not operate the appliance for a couple of hours.
Burner is not igniting or only partially lighting.	Burner parts may not be clean or dry.	Ensure that parts of the appliance are dry and clean.
Burner sounds noisy.	-	This is normal. The noise may reduce as they heat up.
Noise	-	It is normal for some metal parts on the cooker to produce noise when in use.

6.2 TRANSPORT

If you need to transport the product, use the original product packaging and carry it using its original case. Follow the transport signs on the packaging. Tape all independent parts to the product to prevent damaging the product during transport.

If you do not have the original packaging, prepare a carriage box so that the appliance, especially the external surfaces of the product, is protected against external threats.

7. TECHNICAL SPECIFICATIONS

7.1 INJECTOR TABLE

G30 28/30 mbar 589kW 8,1 g/h IL - I3B/P Class:3	LPG G30 28-30 mbar
MEDIUM BURNER	
DIA. of INJECTOR (1/100mm)	65
NOMINAL RATING (KW)	1,75
CONSUMPTION	127,2 g/h
MEDIUM BURNER	
DIA. of INJECTOR (1/100mm)	65
NOMINAL RATING (KW)	1,75
CONSUMPTION	127,2 g/h
SMALL BURNER	
DIA. of INJECTOR (1/100mm)	50
NOMINAL RATING (KW)	1
CONSUMPTION	72,7 g/h
WOK BURNER	
DIA. of INJECTOR (1/100mm)	96
NOMINAL RATING (KW)	3,6
CONSUMPTION	261,8 g/h

5235539

